



HILOMAST LLC

BROADCAST MASTS

Specification

- 48' Extended Height
- 8.7' Retracted Height
- 8 Sections
- 4" Diameter Top Section
- 200 lbs Vertical Head load
- Basic Mast Weight of 280 lbs
- Base Diameter of 9"
- Anodized Finish
- Drain Holes
- Quick Release Pinned Top Spigot
- Complete With Roof Bearing and Mag Switch
- 56 mph Unguyed Wind Speed with 12 Sq ft Surface Area

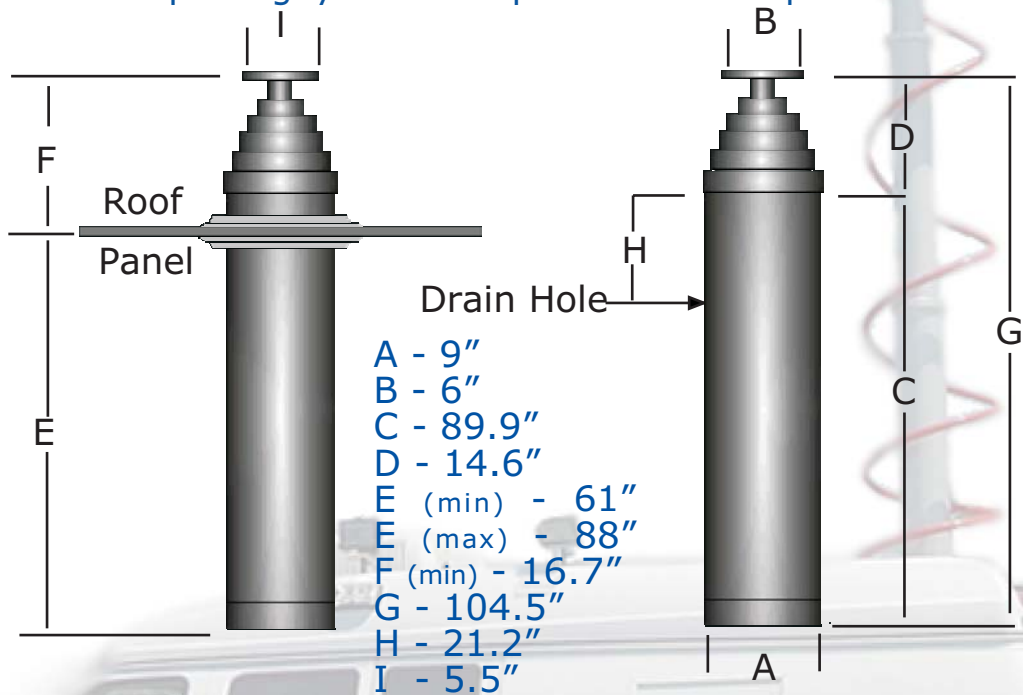

Benefits & Advantages

- No Metal-to-Metal Contact, Reduces Wear & Failure Rate
- Drawn Pneumatic Quality Tube, Extends Seal Life
- Interchangeable With Competitors Product
- Split Roof Bearing Design, for Ease Of Fitting
- USA Service Centers Offer Local Support
- Regular Delivery from Stock
- One Piece Molded Seal for Improved Performance
- Reduced Frequency and Low cost of Service & Maintenance

BR48 Spec Sheet

Hilomast LLC

402 Chairman Court
Debary FL32713 USA
Tel: +1 (386) 668-6784
Fax: +1 (386) 668-6794
Email: sales@hilomast.com
Web: www.hilomast.com